



NEW! **DeBurr-Z**
CNC Deburring Tool
with
Compression and Extension Float

- Deburr parts quickly and consistently on the CNC machine eliminating the need for tedious hand work.
- The DeBurr-Z floats in both compression and extension allowing the cutting tool to follow the top edges or underside edges of the work piece, even when these are not clearly defined like in the case of castings and cross holes.
- Adjust the force by turning the knurled sleeve. Increase or decrease the pressure depending on the type of material and desired edge break. There is no need to disassemble or change springs.
- A wide range of burr cutting tools are available to suit your particular application.
- Also recommended for engraving. The compression float allows a faster approach to the work piece, and marking on curved surfaces.

CNC axial floating tool holder for deburring and chamfering. Here are a few example applications.

Deburring Top Edges



Underside Edges

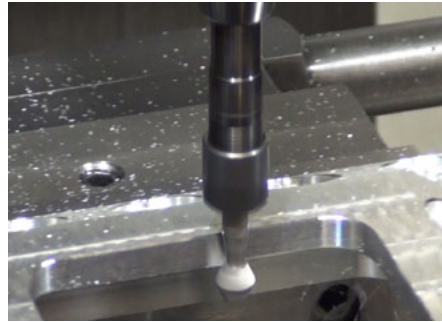

Intersecting Edges

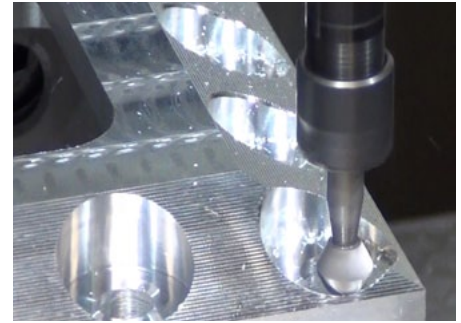

Chamfering holes on a curved surface presents a problem for conventional methods.

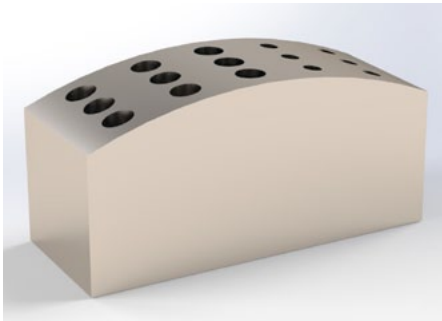

Using a standard countersink tool results in inconsistent edge breaks.



Going around the holes with the axially floating DeBurr-Z produces consistent results.



The DeBurr-Z can also be used for engraving. It allows a faster approach to the work piece and the ability to mark on curved surfaces. We offer combination deburring/engraving cutting tools.

CNC tool holder for deburring and chamfering

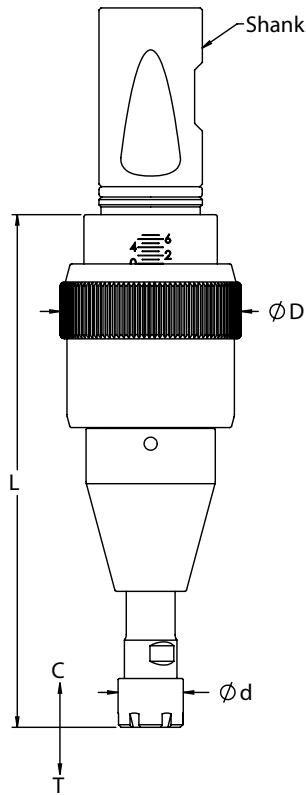

- for deburring, and chamfering on CNC machines.
- floats in compression and extension for deburring the topside or underside edges of the work piece.
- the floating holder allows the cutting tool to follow the edges of the work piece even when these are not clearly defined like in the case of castings or cross holes.
- improves the life of cutting tools thanks to the adjustable compression force.
- speeds up the process by allowing faster approach feed rates.
- the compression and extension force can be simultaneously and equally adjusted for increasing or decreasing the pressure of the cutting tool against the work piece.
- ER11 collet holds a wide variety of burr cutting tools.
- easy programming and installation on the CNC machine.

How to Order

Please select the DeBurr-Z (A) and shank (B) to fit your application. Please order ER11 collets and burs separately.

(A) Model	Order code	Shank	Collets (Capacity)	Max. RPM	Compression C	Extension T	d	D	L	Weight kg
DeBurr-Z	57301	1"	ER11 (2.5-6.5)	10,000	10	10	16	44	128	0.7
	57320	20 mm								
	57325	25 mm								

Note: All dimensions are shown in mm. 25.4mm = 1"

The above tools all include shanks with weldon flats. We do also offer a 20mm shank without flats, please use Order code 57320CY.

We also offer kits for each of the above tools that include the DeBurr-Z, collet for 6.4mm, and one 12.7mm universal ball shape bur. To specify please add 'K' to the end of the above Order codes.



Interchangeable Steep tapers



ER11 Collets

Bur Cutting Tools for use with the DeBurr-Z

We recommend spherical and angular shaped burs. These are available in a variety of sizes, shapes and tooth patterns, from different manufacturers. Below are examples of some of the burs we offer. These are all carbide tools which can be used for a variety of work piece materials including steel, aluminum and cast iron. Please let us know if your application requires a different size or shape. We would be pleased to help.

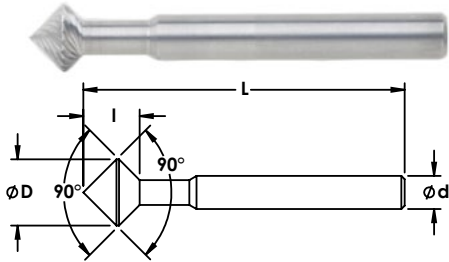

Top edge and underside edge deburring and engraving.

Order code	D	d	L	l
52MM20590W	9.5 (3/8")	6.4	58.5	17
52MM20591W	12.7 (1/2")	6.4	61.5	20

Top edge and underside edge deburring.

52SKN6W	15.9 (5/8")	6.4	60.2	15
---------	-------------	-----	------	----

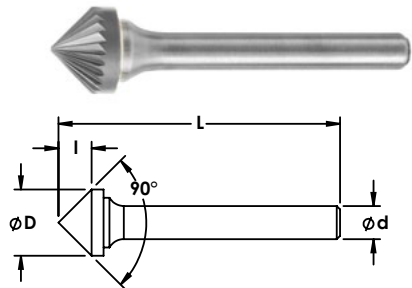

Top edge deburring

Order code	D	d	L	l
52SK3W	9.5 (3/8")	6.4	52.4	4.8
52SK5W	12.7 (1/2")	6.4	54.0	6.4

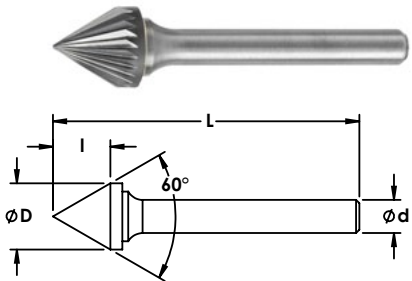

Top edge deburring.

Order code	D	d	L	l
52SJ3W	9.5 (3/8")	6.4	54.0	8.0
52SJ5W	12.7 (1/2")	6.4	58.7	11.0

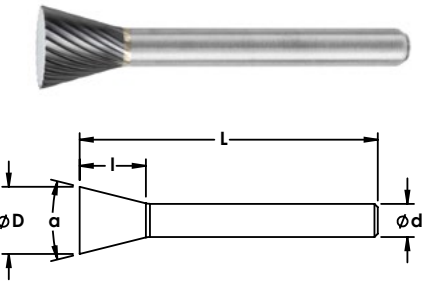

Underside edge deburring.

Order code	D	d	L	l	a
52SN5W	12.7 (1/2")	6.4	57.0	12.7	28°

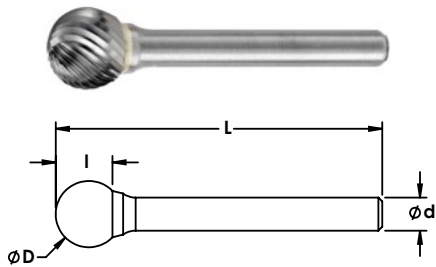

Top edge and underside edge deburring.

Order code	D	d	L	l
52SD2W	6.4 (1/4")	3.2	44.5	5.5
52SD3W	9.5 (3/8")	6.4	52.4	8.0
52SD3WL6	9.5 (3/8")	6.4	160.4	8.0
52SD5W	12.7 (1/2")	6.4	54.0	11.0
52SD5WL6	12.7 (1/2")	6.4	163.5	11.0
52SD6W	15.9 (5/8")	6.4	57.0	14.3
52SD7W	19.0 (3/4")	6.4	63.5	17.5